

RevNo	Revision note	Date	Signature	Checked
3	GENERAL REVISION	04/03/24	IP	IP

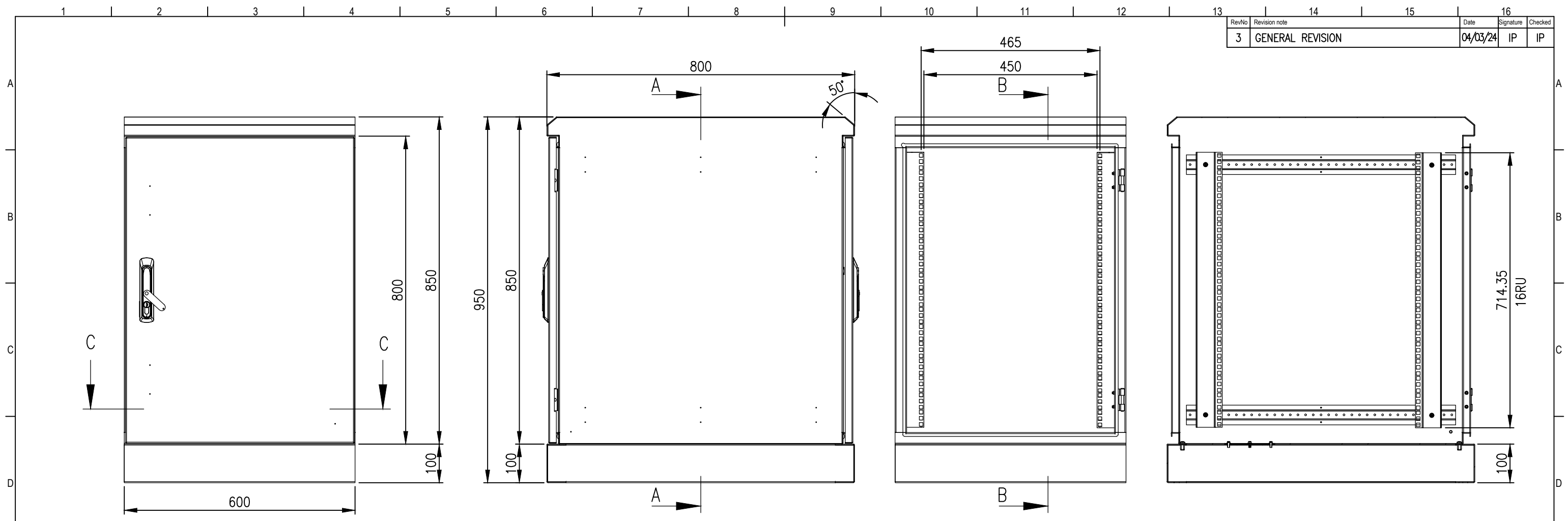

FRONT VIEW

SIDE VIEW

SECTION A-A

SECTION B-B

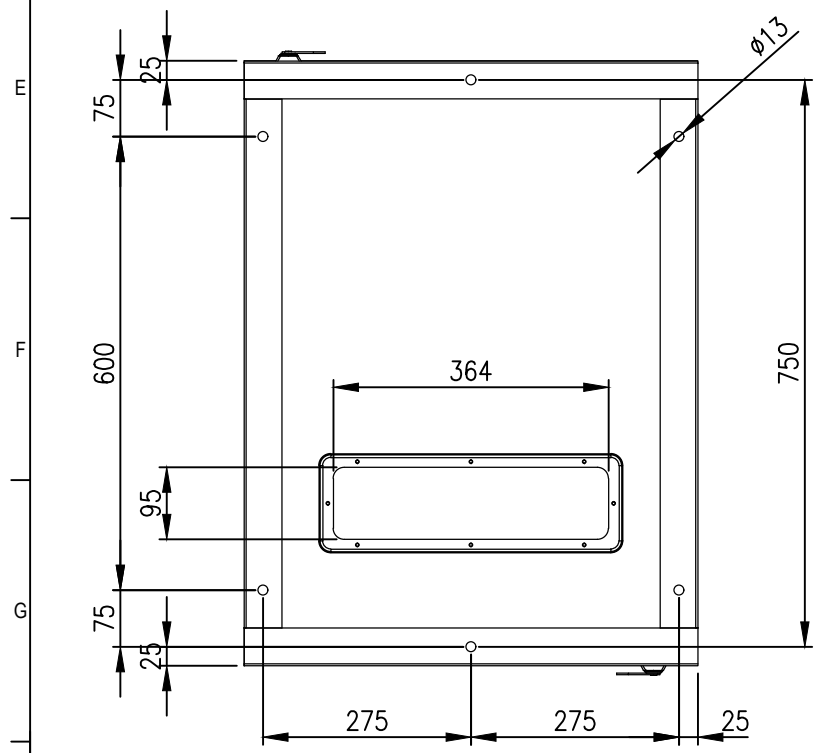

BOTTOM VIEW

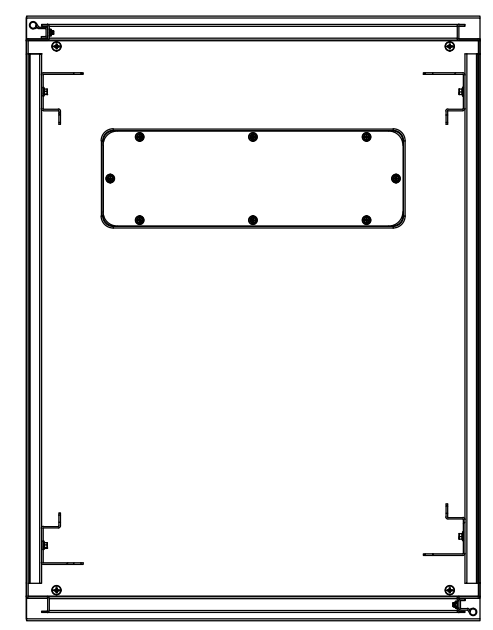

SECTION C-C

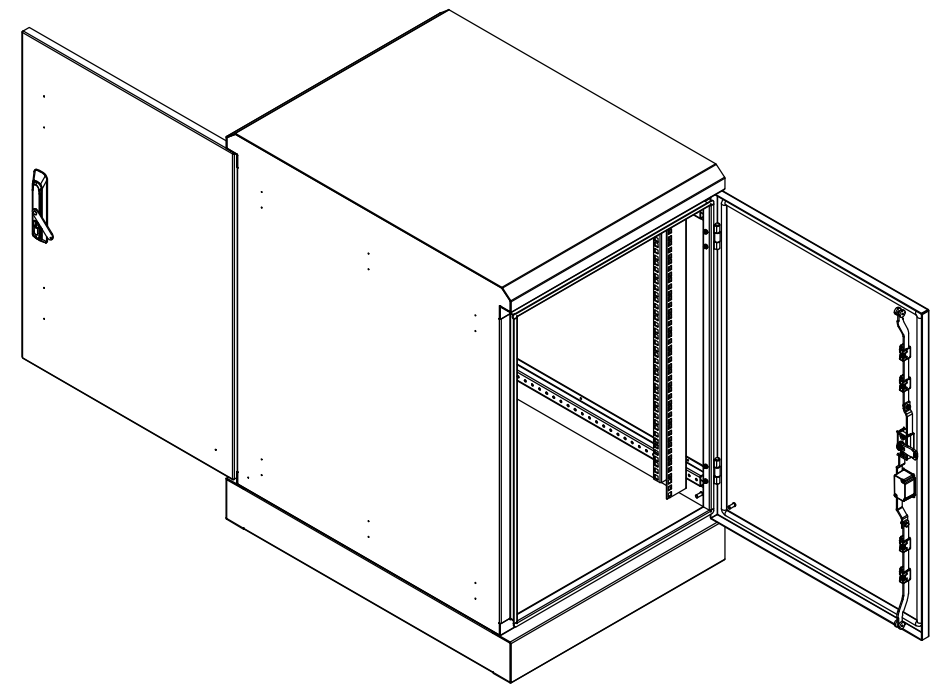

**MATERIAL**  
 BODY: 2.0mm GALVANISED STEEL SHEET  
 DOOR: 2.0mm GALVANISED STEEL SHEET  
 SEAL: POLYURETHANE  
 SURFACE TREATMENT: POWDER-COAT 80-120micron

**PROTECTION: IP66 IK10**  
**STANDARD: IEC/EN/AS60529**

© IP ENCLOSURES 2018.  
 THIS DRAWING SHALL NOT BE COPIED OR REPRODUCED  
 WITHOUT AUTHORISATION FROM IP ENCLOSURES.  
 www.ipenclosures.com.au

Itemref	Quantity	Title/Name, designation, material, dimension etc	Article No./Reference
Designed by IP	Checked by IP	Approved by - date 02/07/18	Filename IP-SD806080-RD
Date 02/07/18		Scale 1:10	
			16RU 850x600x800 IP66 19" DATA RACK
IP-SD806080-RD			Edition 3
			Sheet 1/1