

RevNo	Revision note	Date	Signature	Checked
0	GENERAL REVISION		IP	IP

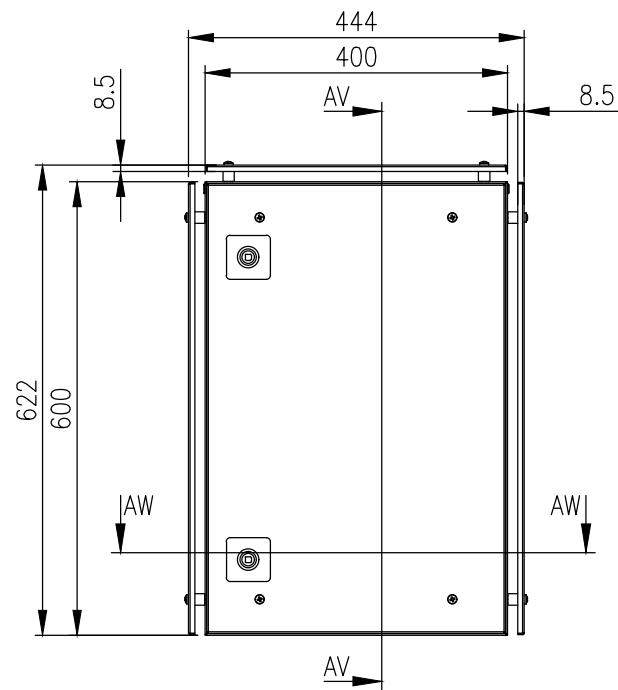

FRONT VIEW



FRONT VIEW

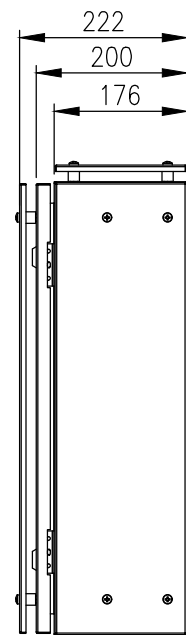

RIGHT SIDE VIEW

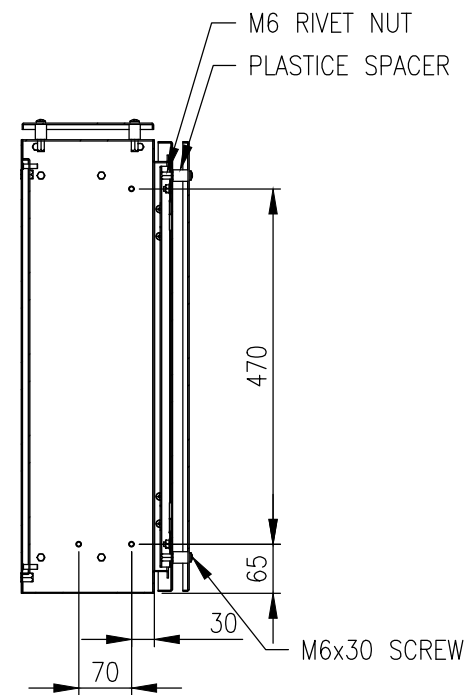

SECTION AV-AV

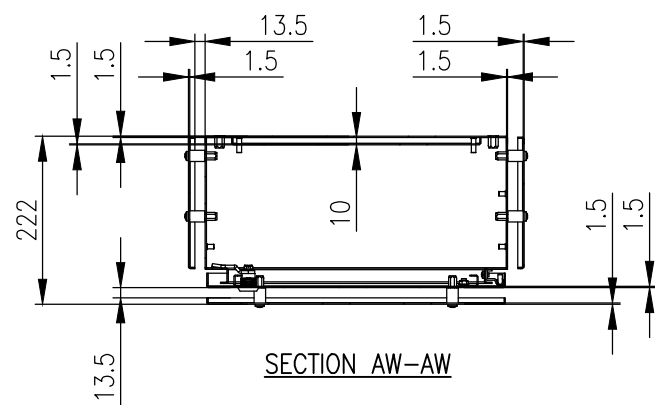
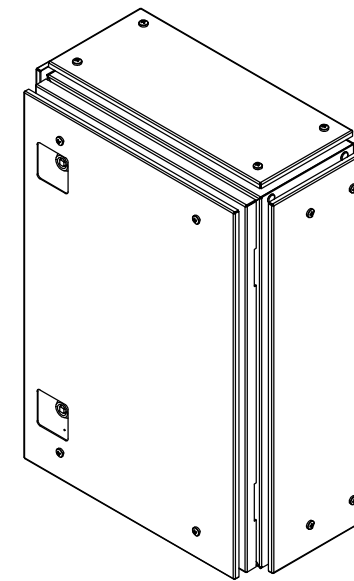

SECTION AW-AW

MATERIAL
 BODY: 1.5mm GRADE 316L STAINLESS STEEL
 DOOR: 1.5mm GRADE 316L STAINLESS STEEL
 SUN SHIELDS: 1.5mm GRADE 316L STAINLESS STEEL
 with STAINLESS STEEL FASTENERS
 DEVICE PLATE: 1.5mm GALVANISED STEEL SHEET
 SEAL: POLYURETHANE

MASS: 21.5Kg.

PROTECTION: IP66 IK10 (NEMA 4x)
 STANDARD: IEC/EN62208, IEC/EN/AS60529

© IP ENCLOSURES 2025.
 THIS DRAWING SHALL NOT BE COPIED OR REPRODUCED
 WITHOUT AUTHORISATION FROM IP ENCLOSURES.
 www.ipenclosures.com.au

Itemref	Quantity	Title/Name, designation, material, dimension etc			Article No./Reference	
Designed by IP	Checked by IP	Approved by - date 19/03/25	Filename IP-SS604020SUN	Date 19/03/25	Scale 1:10	
			600x400x200 316SS ELECTRICAL ENCLOSURE with SUNSHIELDS			
			IP-SS604020SUN		Edition 0	Sheet 1/1